

# BIALITI<sup>®</sup>

HERRAJES

HERRAJES IMPORTADOS  
2009 - 2010



HERRAJES IMPORTADOS



PRODUCTOS Y SERVICIOS PARA LA INDUSTRIA  
DEL MUEBLE Y LA MADERA

[www.dstricondor.com](http://www.dstricondor.com)



IMTL 2137  
Manija curva aluminio natural 288 mm  
H. 31.5 mm L. 341 mm C.C. 288 mm



IMTL 2136  
Manija curva aluminio natural 224 mm  
H. 31.5 mm L. 264 mm C.C. 224 mm



IMTL 2135  
Manija curva aluminio natural 192 mm  
H. 31.5 mm L. 227,5 mm C.C. 192 mm



IMTL 2134  
Manija curva aluminio natural 160 mm  
H. 31.5 mm L. 189 mm C.C. 160 mm



IMTL 4863  
Manija níquel cepillado  
C.C. 96 mm H. 28 mm  
L. 140 mm W. 11 mm



IMTL 0376  
Manija pestaña níquel satinado  
C.C. 32 mm H. 24 mm L. 90 mm W. 29 mm



IMTL 6255  
Manija arco níquel cepillado 64 mm  
H. 25 mm L. 103 mm W. 7 mm



IMTL 6256  
Manija arco níquel cepillado 96 mm  
H. 25 mm L. 136 mm W. 7 mm



IMTL 5724  
Manija zamak - níquel  
cepillada 128 mm  
H. 23 mm L. 159 mm W. 13 mm



IMTL 5723  
Manija zamak - níquel  
cepillada 96 mm  
H. 23 mm L. 128 mm W. 13 mm



IMTL 6675  
Manija Zamak níquel  
sepillado 128 mm  
H. 24 mm L. 184 mm W. 23 mm



IMTL 6672  
Manija Zamak níquel sepillado 96 mm  
H. 19 mm L. 139 mm W. 17 mm



IMTL 5113  
Manija arco cilíndrica níquel  
satinado 96 mm.  
C.C. 96 mm H. 29 mm  
W. 11 mm L. 114 mm



IMTL 5111  
Manija arco cilíndrica níquel  
satinado 64 mm.  
C.C. 64 mm H. 23 mm  
W. 11 mm L. 81 mm



IMTL 5115  
Manija arco cilíndrica níquel  
satinado 128 mm.  
C.C. 128 mm H. 29 mm  
W. 11 mm L. 145 mm



IMTL 6768  
Manija arco níquel satinado  
C.C. 96 mm H. 24 mm L. 110 mm



IMTL 6163  
Manija arco níquel satinado  
C.C. 96 mm H. 24 mm  
L. 128 mm W. 12 mm



IMTL 3531  
Manija pestaña aluminio natural brillante 64 mm  
H. 43 mm L. 90 mm W. 17 mm



IMTL 3530  
Manija pestaña aluminio natural brillante 32 mm  
H. 43 mm L. 50 mm W. 17 mm



IMTL 1516  
Manija aluminio cepillado en C 160 mm  
H. 34 mm L. 169 mm W. 20 mm



IMTL 3543  
Manija plana aluminio natural brillante 128 mm  
H. 25 mm L. 152 mm



IMTL 3542  
Manija plana aluminio natural brillante 64 mm  
H. 25 mm L. 88 mm



IMTL 3541  
Manija plana aluminio natural brillante 32 mm  
H. 25 mm L. 56 mm



IMTL 1596  
Manija aluminio cepillado en C 96 mm  
H. 32 mm L. 110 mm W. 20 mm



IMTL 3084  
Manija aluminio natural plana 128 mm  
H. 19 mm L. 139 mm W. 8 mm



IMTL 3083  
Manija aluminio natural plana 96 mm  
H. 19 mm L. 107 mm W. 8 mm



IMTL 2235  
Manija semicurva aluminio natural brillante 96 mm  
H. 31.5 mm L. 131 mm CC. 96 mm



IMTL 2236  
Manija semicurva aluminio natural brillante 128 mm  
H. 31.5 mm L. 170 mm CC. 128 mm



IMTL 3881  
Manija cilíndrica aluminio natural cromo 224 mm  
H. 34 mm L. 236 mm Ø. 15 mm



IMTL 3880  
Manija cilíndrica aluminio natural cromo 128 mm  
H. 34 mm L. 138 mm Ø. 15 mm



IMTL 3879  
Manija cilíndrica aluminio natural cromo 96 mm  
H. 34 mm L. 106 mm Ø. 15 mm



IMTL 5343  
Manija arco puntos níquel satinado C.C. 96 mm H. 27 mm W. 17 mm L. 135 mm



IMTL 6977  
Manija de incrustar rectangular níquel cepillado L. 115 mm W. 40 mm



IMTL 6973  
Manija de incrustar media luna níquel cepillado W. 47 mm Ø. 35 mm L. 47 mm



IMTL 6975  
Manija de incrustar rectangular níquel cepillado L. 85 mm W. 40 mm

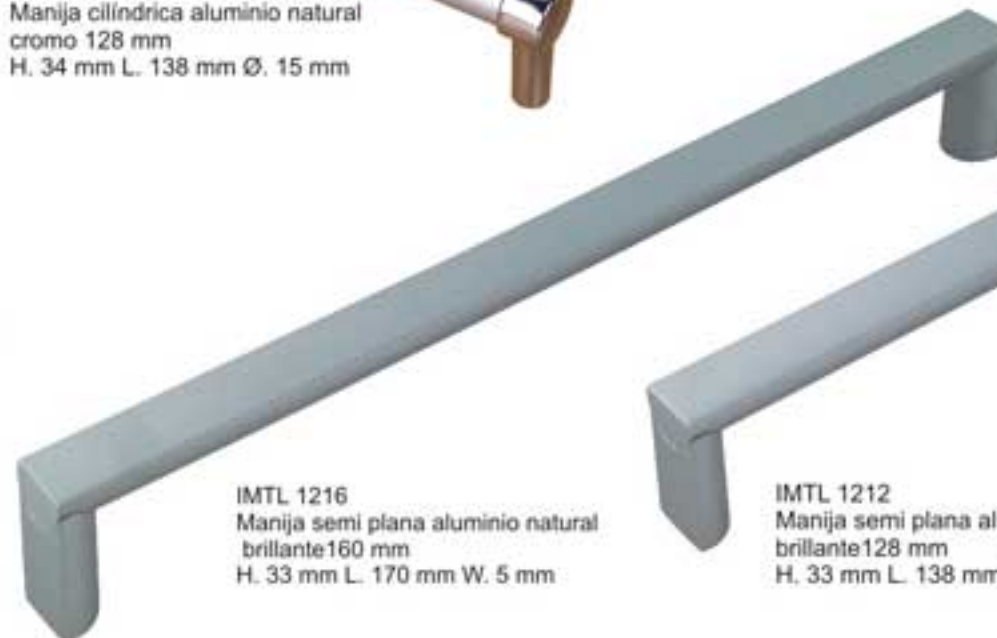

IMTL 1216  
Manija semi plana aluminio natural brillante 160 mm  
H. 33 mm L. 170 mm W. 5 mm



IMTL 1212  
Manija semi plana aluminio natural brillante 128 mm  
H. 33 mm L. 138 mm W. 5 mm



IMTL 1296  
Manija semi plana aluminio natural brillante 96 mm  
H. 33 mm L. 106 mm W. 5 mm



**NUEVO** **NUEVO** **NUEVO** **NUEVO** **NUEVO** **NUEVO**

IMTA 0196 Manija cilíndrica acero inoxidable Tubular 12 mm - 96 mm  
 IMTA 0128 Manija cilíndrica acero inoxidable Tubular 12 mm - 128 mm  
 IMTA 0160 Manija cilíndrica acero inoxidable Tubular 12 mm - 160 mm  
 IMTA 0124 Manija cilíndrica acero inoxidable Tubular 12 mm - 224 mm  
 IMTA 0120 Manija cilíndrica acero inoxidable Tubular 12 mm - 320 mm  
 IMTA 0180 Manija cilíndrica acero inoxidable Tubular 12 mm - 480 mm



IMTL 3537  
 Manija pestaña natural brillante 128 mm  
 Material: Aluminio  
 H. 27 mm L. 140 mm W. 30 mm

IMTL 8923  
 Manija cilíndrica acero inoxidable  
 C.C. 288 mm H. 35 mm  
 Ø. 12 mm L. 370 mm

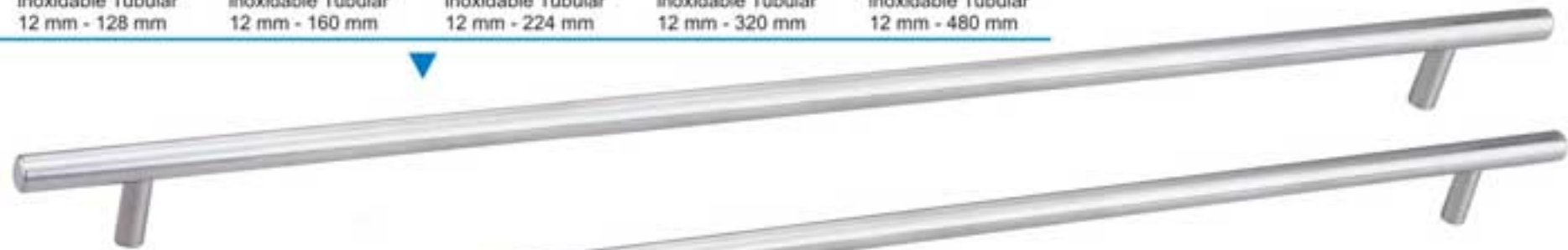

IMTL 8924  
 Manija cilíndrica acero  
 C.C. 224 mm H. 35 mm  
 Ø. 12 mm L. 300 mm

IMTL 8925  
 Manija cilíndrica acero inoxidable  
 C.C. 224 mm H. 35 mm  
 Ø. 12 mm L. 300 mm

IMTL 8928  
 Manija cilíndrica acero  
 C.C. 128 mm H. 35 mm  
 Ø. 12 mm L. 178 mm

IMTL 8929  
 Manija cilíndrica acero inoxidable  
 C.C. 128 mm H. 35 mm  
 Ø. 12 mm L. 178 mm

IMTL 8996  
 Manija cilíndrica acero  
 C.C. 96 mm H. 35 mm  
 Ø. 12 mm L. 138 mm

IMTL 8997  
 Manija cilíndrica acero inoxidable  
 C.C. 96 mm H. 35 mm  
 Ø. 12 mm L. 138 mm



1  
 IMTL 1232  
 Manija aluminio natural enfrentada 160 mm  
 H. 35 mm L. 173 mm



2  
 IMTL 1233  
 Manija aluminio natural enfrentada 160 mm  
 H. 35 mm L. 173 mm

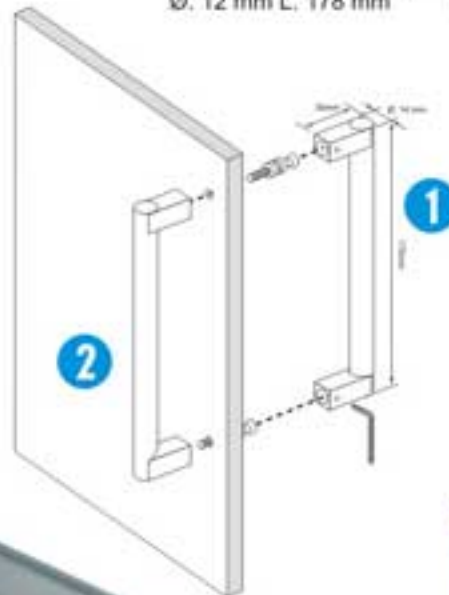

2

1



IMTL 3519  
 Manija triangular aluminio natural brillante 192 mm  
 H. 27 mm L. 212 mm W. 6 mm

IMTL 3522  
 Manija triangular aluminio natural brillante 224 mm  
 H. 27 mm L. 245 mm W. 6 mm



IMTL 3516  
 Manija triangular aluminio natural brillante 160 mm  
 H. 27 mm L. 180 mm W. 6 mm



IMTL 9128  
 Manija acero inoxidable base rectangular 128mm  
 H. 38 mm L. 148 mm Ø. 10 mm



IMTL 9224  
 Manija acero inoxidable base rectangular 224mm  
 H. 38 mm L. 244 mm Ø. 10 mm

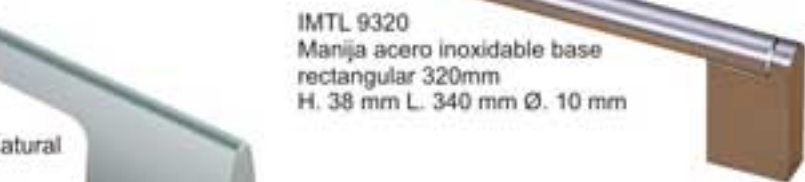

IMTL 9320  
 Manija acero inoxidable base rectangular 320mm  
 H. 38 mm L. 340 mm Ø. 10 mm



IMTL 9165  
Botón cilíndrico aluminio natural  
H. 23 mm W. 14 mm



IMTL 5900  
Botón cuadrado  
H. 23 mm L. 15 mm  
W. 15 mm



IMTL 4141  
Botón cilíndrico aro inoxidable  
H. 25 mm W. 12 mm



IMTL 5008  
Botón aluminio natural  
H. 21 mm W. 16 mm



IMTL 9135  
Botón cilíndrico níquel cepillado  
H. 20 mm W. 9 mm



IMTL 4071  
Botón níquel cepillado  
H. 21 mm W. 14 mm



IMTL 8197  
Botón ovalado níquel cepillado largo  
H. 23 mm W. 12 mm  
L. 40 mm



IMTL 7825  
Botón pestaña níquel satinado  
H. 21 mm L. 26 mm W. 17 mm



IMTL 5333  
Botón puntos satin níquel  
H. 24 mm Ø. 27 mm



IMTL 7830  
Botón pestaña níquel Cepillada  
H. 20 mm L. 34 mm  
W. 8 mm



IMTL 3418  
Manija acero inoxidable 192 mm  
H. 39 mm L. 205 mm Ø. 20 mm



IMTL 3419  
Manija acero inoxidable 256 mm  
H. 39 mm L. 268 mm Ø. 20 mm



IMTL 0531  
Manija níquel satinado rectangular 32 mm.  
H. 23 mm L. 48 mm W. 11 mm



IMTL 6141  
Manija arco níquel satinado  
C.C. 64 mm H. 17 mm W. 7 mm L. 89 mm



IMTL 6143  
Manija arco níquel satinado  
C.C. 96 mm H. 24 mm W. 7 mm L. 128 mm



IMTL 2423  
Manija níquel satinado - madera  
C.C. 96 mm H. 29 mm  
L. 147 mm W. 14 mm



IMTL 9208  
Botón redondo níquel cepillado pequeño  
H. 27 mm W. 18 mm

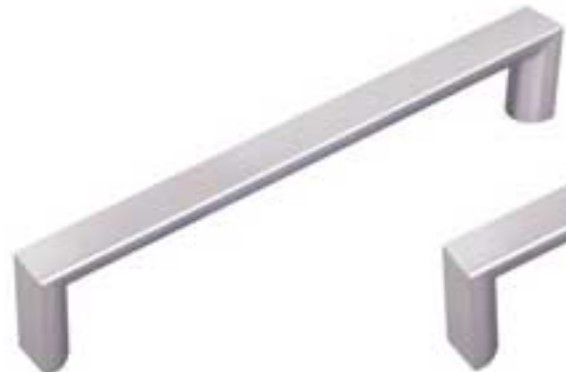

IMTL 5668  
Manija zamak 128 mm  
H. 28 mm L. 136 mm W. 12 mm



IMTL 5667  
Manija zamak 96 mm  
H. 26 mm L. 105 mm W. 11 mm



IMTL 5666  
Manija zamak 64 mm  
H. 25 mm L. 72 mm W. 10.5 mm



IMTL 3512  
Manija en C níquel satinado cromada 128 mm  
H. 30 mm L. 142 mm W. 7.5 mm



IMTL 3596  
Manija en C níquel satinado cromada 96 mm  
H. 30 mm L. 109 mm W. 7.5 mm



IMTL 3038  
Manija arco perforada níquel cepillado  
C.C. 96 mm H. 25 mm L. 145 mm W. 15 mm



IMTL 9995  
Manija arco níquel cepillado  
C.C. 128 mm H. 28 mm  
L. 145 mm W. 15 mm



IMTL 9993  
Manija arco níquel cepillado  
C.C. 96 mm H. 33 mm  
L. 105 mm W. 15 mm



IMTL 3127  
Manija zamak 96 mm  
H. 26 mm L. 130 mm W. 25 mm



IMTL 0459  
Manija arco plana níquel cepillado 128 mm  
H. 26 mm L. 159 mm W. 25 mm



IMTL 5988  
Manija aluminio natural rectangular 32 mm.  
H. 18 mm L. 50 mm W. 12 mm



IMTL 0541  
Manija sobreponer clóset níquel satinado 87 mm.  
H. 12 mm L. 87 mm W. 11 mm



IMTL 0843  
Manija Zamak 96 mm  
H. 25 mm L. 130 mm W. 6 mm



IMTL 6635  
Manija arco dorado eco  
C.C. 76 mm H. 24 mm L. 130 mm



IMTL 6636  
Manija arco níquel cepillado eco  
C.C. 76 mm H. 24 mm L. 130 mm



IMTL 3302  
Manija curva plástica blanca  
C.C. 64 mm H. 35 mm L. 73 mm



IMTL 2323  
Manija arco plástica níquel satinado  
C.C. 96 mm H. 25 mm  
W. 11 mm L. 130 mm



IMTL 8023  
Manija arco porcelana blanca - dorado  
C.C. 76 mm H. 32 mm L. 128 mm



IMTL 8011  
Manija arco madera roble - pavonada  
C.C. 76 mm H. 30 mm  
L. 130 mm



IMTL 8022  
Manija arco porcelana blanca - pavonada  
C.C. 76 mm H. 29 mm  
L. 128 mm



IMTL 3301  
Manija curva plástica blanca  
C.C. 96 mm H. 35 mm L. 105 mm



IMTL 3404  
Botón plástico champaña  
H. 25 mm Ø. 34 mm



IMTL 8026  
Manija arco porcelana flor - pavonada  
C.C. 76 mm H. 29 mm  
L. 128 mm



IMTL 4226  
Manija arco grabado cobrizada  
C.C. 93 mm H. 20 mm  
L. 120 mm



IMTL 4426  
Manija arco liso cobrizada  
C.C. 80 mm H. 22 mm  
L. 115 mm



IMTL 3305  
Manija curva plástica champaña  
C.C. 64 mm H. 32 mm L. 73 mm



IMTL 3402  
Botón plástico negro  
H. 25 mm Ø. 34 mm



IMTL 3304  
Manija curva plástica champaña  
C.C. 96 mm H. 35 mm L. 105 mm



IMTL 3401  
Botón plástico blanco  
H. 25 mm Ø. 34 mm



IMTL 5602  
Manija en U pavonada Inglés  
C.C. 76 mm H. 32 mm  
L. 92 mm



IMTL 4220  
Manija arco grabado pavonada  
C.C. 93 mm H. 20 mm  
L. 120 mm



IMTL 4420  
Manija arco liso pavonada  
C.C. 80 mm H. 22 mm  
L. 115 mm



IMTL 3303  
Manija curva plástica negra  
C.C. 64 mm H. 32 mm L. 73 mm



IMTL 8166  
Botón porcelana flor - Pavonado  
H. 23 mm Ø. 30 mm





IMTL 7889  
Botón níquel cepillado mediano  
H. 25 mm Ø. 25 mm



IMTL 7763  
Botón níquelado hongo  
H. 22 mm Ø. 30 mm



IMTL 7885  
Botón níquel cepillado alto  
H. 31 mm W. 35 mm



IMTL 7716  
Botón cobrizado puntos  
H. 22 mm Ø. 35 mm



IMTL 7710  
Botón anticado pavonado puntos  
H. 22 mm Ø. 35 mm



IMTL 9772  
Botón lagrima cobrizado  
L. 65 mm



IMTL 385D  
Botón porcelana champaña grande  
H. 22 mm Ø. 32 mm



IMTL 788N  
Botón cromado mediano  
H. 22 mm Ø. 25 mm



IMTL 7762  
Botón níquelado hongo  
H. 22 mm Ø. 30 mm



IMTL 8193  
Botón ovalado níquel cepillado  
H. 22 mm W. 20 mm L. 36 mm



IMTL 0946  
Botón argolla cobrizado  
Ø. 38 mm



IMTL 0942  
Botón argolla pavonado  
Ø. 38 mm



IMTL 7430  
Botón cobrizado  
H. 17 mm Ø. 35 mm



IMTL 385C  
Botón porcelana champaña pequeña  
H. 15 mm Ø. 25 mm



IMTL 7881  
Botón dorado mediano  
H. 22 mm Ø. 25 mm



IMTL 7761  
Botón dorado hongo  
H. 22 mm Ø. 30 mm



IMTL 7888  
Botón dorado cepillado mediano  
H. 25 mm Ø. 25 mm



IMTL 7400  
Botón cobrizado  
H. 17 mm Ø. 35 mm



IMTL 7240  
Botón cobrizado  
H. 19 mm Ø. 34 mm



IMTL 7260  
Botón cobrizado  
H. 24 mm Ø. 38 mm



IMTL 5712  
Botón porcelana blanca grande  
H. 22 mm Ø. 32 mm



IMTL 7882  
Botón dorado alto  
H. 25 mm Ø. 28 mm



IMTL 7890  
Botón anticado pavonado  
cepillado mediano  
H. 22 mm Ø. 25 mm



IMTL 8151  
Botón madera roble - pavonado  
H. 26 mm Ø. 30 mm



IMTL 3853  
Botón porcelana flor roja grande  
H. 22 mm Ø. 32 mm



IMTL 385F  
Botón porcelana flor azul grande  
H. 22 mm Ø. 32 mm



IMTL 3856  
Botón porcelana  
flor champaña  
H. 22 mm Ø. 32 mm



IMTL 385B  
Botón porcelana blanca pequeña  
H. 15 mm Ø. 25 mm



IMTL 2254  
Botón madera roble pequeño  
H. 23 mm Ø. 25 mm



IMTL 2255  
Botón madera roble mediano  
H. 25 mm Ø. 30 mm



IMTL 2256  
Botón madera roble grande  
H. 28 mm Ø. 35 mm



IMTL 3852  
Botón porcelana flor roja pequeña  
H. 15 mm Ø. 25 mm



IMTL 385A  
Botón porcelana flor azul pequeña  
H. 15 mm Ø. 25 mm



IMTL 3678  
Botón porcelana 2  
rosas mediana  
H. 22 mm Ø. 27 mm



IMTL 3851  
Botón porcelana blanca  
anillo dorado grande  
H. 22 mm Ø. 32 mm



IMRP 0075  
Rodachina plataforma  
nylon negra  
Ø 75 mm  
carga 80 kg



IMRA 0075  
Rodachina plataforma aluminio  
solido natural brillante Ø 75 mm  
carga 60 kg



IMRV 0075  
Rodachina acrilica  
transparente verde  
Ø 75 mm  
carga 40 kg



IMRW 0075  
Rodachina plataforma  
madera roble  
Ø 75mm  
carga 35 kg



IMRW 0050  
Rodachina plataforma  
madera roble  
Ø 50 mm  
carga 25 kg



IMRW 0150  
Rodachina plataforma  
madera roble  
freno Ø 50 mm  
carga 25 kg



IMRR0150  
Rodachina Doble  
Rueda Poliuretano  
Transp 50mm con  
Freno carga 70 Kilos



IMRR0053  
Rodachina Doble Rueda  
Poliuretano Transparente  
50mm carga 70 Kilos



IMRP 0175  
Rodachina plataforma  
nylon negra  
freno Ø 75 mm  
carga 80 kg



IMRA 0175  
Rodachina plataforma aluminio  
solido natural brillante freno  
Ø 75 mm carga 60 kg



IMRV 0175  
Rodachina acrilica  
transparente verde  
freno Ø 75 mm  
carga 40 kg



IMRW 0175  
Rodachina plataforma  
madera roble  
freno Ø 75mm  
carga 35 kg



IMRR0055  
Rodachina  
Poliuretano  
Transparente  
50mm  
carga 45 Kilos



IMRR0152  
Rodachina  
Poliuretano  
Transparente  
50mm Con Freno  
carga 45 Kilos



IMRR0054  
Rodachina BOLA  
Poliuretano  
Transparente  
50mm  
carga 40 Kilos



IMRR0151  
Rodachina BOLA  
Poliuretano  
Transp 50mm  
Con Freno  
carga 40 Kilos



IMRA 0180  
Rodachina plataforma lujo aluminio  
solido natural brillante freno  
Ø 80 mm carga 30 kg



IMRA 0080  
Rodachina plataforma lujo aluminio  
solido natural brillante Ø 80 mm  
carga 30 kg



IMRR 0161  
Rodachina plataforma bola  
maciza PVC gris Ø 50 mm  
carga 40 kg  
IMRR 0162  
Rodachina plataforma bola  
con freno



IMRR 0061  
Rodachina plataforma bola  
maciza PVC verde Ø 50 mm  
carga 40 kg  
IMRR 0062  
Rodachina plataforma bola  
con freno



IMRR 0261  
Rodachina plataforma bola  
maciza PVC ocre Ø 50 mm  
carga 40 kg  
IMRR 0262  
Rodachina plataforma bola  
con freno



IMRR0135  
Rodachina  
Poliuretano  
Transparente  
35mm Con Freno  
carga 35 Kilos



IMRR0035  
Rodachina Poliuretano  
Transparente 35mm  
carga 35 Kilos



IMRC 0075  
Rodachina plataforma acrílica  
Ø 75 mm - carga 40 kg



IMRN 0064  
Rodachina plataforma PVC  
negra Ø 64 mm  
carga 50 kg



IMRA 0064  
Rodachina plataforma PVC  
azul Ø 64 mm  
carga 50 kg



IMRB 0064  
Rodachina plataforma PVC  
blanca Ø 64 mm  
carga 50 kg



IMRS 0075  
Rodachina plataforma PVC  
transparente  
gris Ø 75 mm  
carga 55 kg



IMRS 0475  
Rodachina plataforma PVC  
transparente  
negra Ø 75 mm  
carga 55 kg



IMRS 0275  
Rodachina plataforma PVC  
transparente  
ocre Ø 75 mm  
carga 55 kg



IMRC 0175  
Rodachina plataforma  
acrílica freno Ø 75 mm  
carga 40 kg



IMRN 0164  
Rodachina plataforma PVC  
negra freno Ø 64 mm  
carga 50 kg



IMRA 0164  
Rodachina plataforma PVC  
azul freno Ø 64 mm  
carga 50 kg



IMRB 0164  
Rodachina plataforma PVC  
blanca freno Ø 64 mm  
carga 50 kg



IMRS 0175  
Rodachina plataforma PVC  
transparente  
gris freno Ø 75 mm  
carga 55 kg



IMRS 0575  
Rodachina plataforma PVC  
transparente  
negra freno Ø 75 mm  
carga 55 kg



IMRS 0375  
Rodachina plataforma PVC  
transparente  
ocre freno Ø 75 mm  
carga 55 kg



IMRP QF50  
Rodachina plataforma  
nylon freno Ø 50 mm  
carga 35 kg



IMRR 0050  
Rodachina espigo  
roscado nylon Ø 50 mm  
carga 35 kg



IMRE 0050  
Rodachina espigo  
presión nylon Ø 50 mm  
carga 35 kg



IMRP 0050  
Rodachina plataforma  
nylon Ø 50 mm  
carga 35 kg



IMRP 0040  
Rodachina plataforma  
nylon Ø 40 mm  
carga 25 kg



IMRP 0130  
Rodachina plataforma  
nylon Ø 30 mm  
carga 15 kg



IMRM 0040  
Rodachina bola maciza  
Ø40 mm  
carga 35 kg



IMRM 0050  
Rodachina bola maciza  
Ø 50 mm  
carga 45 kg

Nivel - expandible hasta 3cm

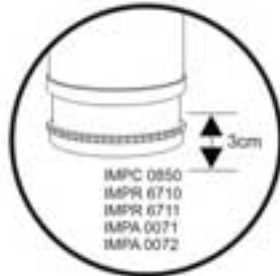

IMPC 0850  
IMPR 6710  
IMPR 6711  
IMPA 0071  
IMPA 0072

**NUEVO**

**NUEVO**



IMPC 0850  
Pata mesa  
redonda  
níquel cepillado  
H. 850 mm

IMPR 6710  
Pata mesa  
redonda  
cromada  
H. 710 mm

IMPR 6711  
Pata mesa  
redonda  
níquel cepillado  
H. 710 mm



IMPA 1506  
Pata acero  
H. 60 mm



IMPA 1510  
Pata acero  
H. 100 mm



IMPMP 0100  
Pata metálica  
satin níquel  
H. 100 mm



IMPMP 0150  
Pata metálica  
satin níquel  
H. 150 mm



IMPA0072  
Pata mesa  
cilíndrica  
de 60 x 715mm  
cromada

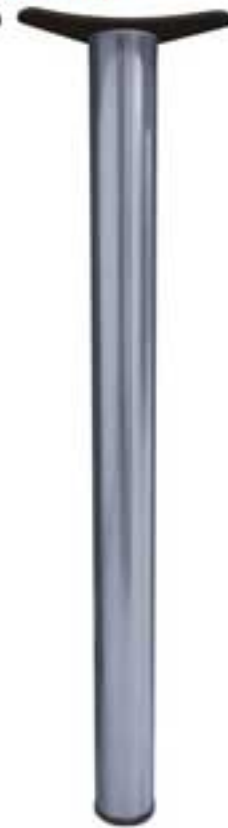

IMPA0071  
Pata mesa  
cilíndrica  
de 60 x 715mm  
satin níquel



IMPC 0250  
Pata cuadrada aluminio  
natural brillante  
H. 250mm L. 35 mm W. 35 mm



IMPC 0200  
Pata cuadrada aluminio  
natural brillante  
H. 200mm L. 35 mm W. 35 mm

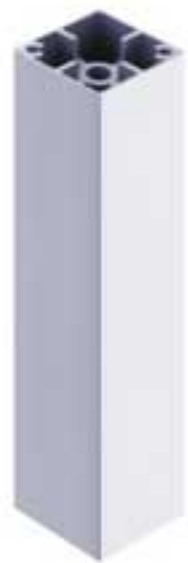

IMPC 0150  
Pata cuadrada aluminio  
natural brillante  
H. 150mm L. 35 mm W. 35 mm



IMPC 0125  
Pata cuadrada aluminio  
natural brillante  
H. 125mm L. 35 mm W. 35 mm



IMPC 0100  
Pata cuadrada aluminio  
natural brillante  
H. 100mm L. 35 mm W. 35 mm



IMPEN 0820  
Nivelador piso 28 mm  
base negra



IMTC 0081  
Tomillo conector para pata  
aluminio cuadrada



IMPMP 3535  
Platina en L aseguradora  
pata aluminio cuadrada  
L. 35 mm W. 35 mm

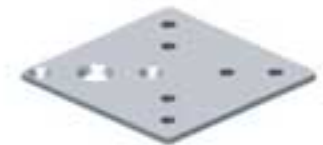

IMPMP 7035  
Platina superior esquina  
pata aluminio cuadrada  
L. 70 mm W. 70 mm



IMBP 6404  
Base inferior pata cuadrada  
aluminio natural brillante  
H. 13 mm L. 56 mm W. 56 mm



IMEC 0701  
Platina superior central  
pata aluminio cuadrada  
L. 70 mm W. 70 mm



IMPS 0083  
Plato superior espiga roscado  
pata aluminio cuadrada  
L. 62 mm W. 50 mm

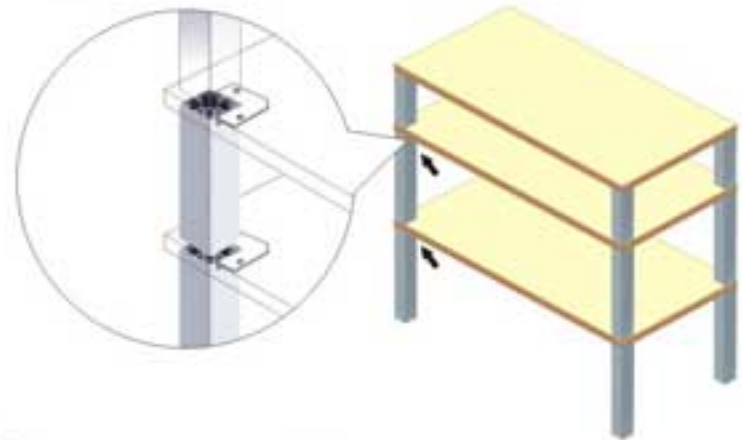



IMPA 2150  
Pata acero  
cilíndrica  
H. 150 mm



IMPA 2100  
Pata acero  
cilíndrica  
H. 100 mm



IMPA 2085  
Pata acero  
cilíndrica  
H. 85 mm



IMPO 0388  
Pata oval cilíndrica  
satin níquel cepillado  
H. 100 mm



IMPA 1686  
Pata alfredo zamak  
satin níquel  
H. 100 mm



IMPA 0686  
Pata alfredo zamak  
satin níquel  
H. 80 mm



IMPA 5281  
Pata Alfredo  
níquel cepillado  
H. 60 mm



IMPA 5231  
Pata Alfredo lujo  
níquel cepillado  
H. 100mm



IMPA 5324  
Pata Sofa zamak  
níquel satinada  
H. 100 mm



IMPA 0696  
Pata conica zamak  
níquel satinada  
H. 100 mm



IMPA 0687  
Pata mueble  
cónica zamak  
satin níquel  
H. 100 mm



IMPA 0674  
Pata cónica  
zamak  
H. 80 mm



IMPA 1671  
Pata cilíndrica zamak  
satin níquel  
H. 100 mm



IMPA 0671  
Pata cilíndrica zamak  
satin níquel  
H. 80 mm



IMPA 6306  
Pata plana aluminio  
natural brillante 110 mm



IMPA 6307  
Pata plana aluminio  
natural brillante 135 mm



IMPJ 1100  
Pata Julia  
níquel cepillado pequeña  
H. 100mm



IMPJ 1125  
Pata Julia  
níquel cepillado mediana  
H. 125mm



IMPJ 1150  
Pata Julia  
níquel cepillado  
grande  
H. 150 mm



IMPA0582  
Pata zamak cónica sin  
nivelador de 100mm  
satin níquel



IMPA0585  
Pata zamak rectangular  
sin nivelador de 100mm  
satin níquel - cromo



OTPA 6083  
Pata Escritorio en H color Negro  
H. 150 mm



OTPG 6083  
Pata Escritorio en H color Gris  
H. 150 mm



OTPA 6085  
Pata Escritorio en H Lamina  
Color Negro  
H. 150 mm



OTPG 6085  
Pata Escritorio en H Lamina  
Color Gris  
H. 150 mm

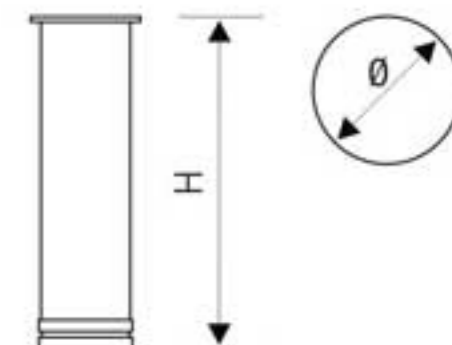

NUEVO

NUEVO

NUEVO

NUEVO

NUEVO

NUEVO



1 IMB 95300  
Bisagra Ferrari 170° ct.



IMBC 0606  
Bisagra Bialiti Parche 26 mm ct.  
para tablero de 12 mm a 18 mm.



IMB 10V06  
Bisagra Ferrari minimax Parche 26 mm ct.  
para tablero de 12 mm a 18 mm.



IMBC 0306  
Bisagra Bialiti parche 35 mm ct.  
para tablero de 15 mm a 18 mm.



IMBC 1500  
Bisagra parche 35 mm ct.  
para tablero de 15 mm a 18 mm.



2 IMB 95730  
Bisagra Ferrari esquinera de 45° ct.



IMBC 0603  
Bisagra Bialiti Semiparche 26 mm ct.  
para tablero de 12 mm a 18 mm.



IMB 10V0B  
Bisagra Ferrari minimax Semiparche 26 mm ct.  
para tablero de 12 mm a 18 mm.



IMBC 0303  
Bisagra Bialiti semiparche 35 mm ct.  
para tablero de 15 mm a 18 mm.



IMBV 1706  
Bisagra Bialiti puerta vidrio 26 mm  
95° tapa cromada nickel

Funcionamiento de las bisagras para puerta esquinera

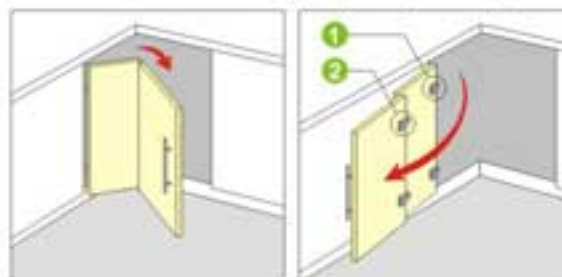

IMBC 0601  
Bisagra Bialiti Interior 26 mm ct.  
para tablero de 12 mm a 18 mm.



IMB 10V0C  
Bisagra Ferrari minimax Interior 26 mm ct.  
para tablero de 12 mm a 18 mm.



IMB 9507C  
Bisagra Ferrari interior 35 mm ct.  
para tablero de 15 mm a 18 mm.



IMBC 0506  
Bisagra Bialiti perfil puerta aluminio 32 mm



IMB PCS01  
Bisagra Ferrari tipo Mighom niquelada ct.



IMBC 0038  
Bisagra Bialiti automatica semiparche



IMBC 0039  
Bisagra Bialiti automatica parche



IMBC 0682  
Bisagra cofre dorado



IMBC 3698  
Broche cofre dorado



IMBB 1091  
3 - 1/2 X 2-3/8 X 2.3 mm  
Bisagra puerta bronce satin  
níquel cabeza  
plana ct.



IMBB 1077  
3 x 2 3/8 X 2.3 mm  
Bisagra puerta bronce  
satin níquel  
cabeza plana ct.

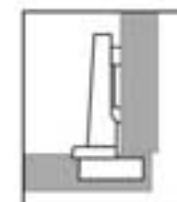

Bisagra Parche



Bisagra Semiparche



Bisagra Interior

**NUEVO**



IMAS 0587  
Chapa Janes alcoba  
satin níquel  
IMBS 0587  
Chapa Janes baño  
satin níquel  
IMAS 3871  
Chapa Bialiti alcoba Eco  
satin níquel  
IMAS 3872  
Chapa Bialiti baño Eco  
satin níquel

IMAC 0587  
Chapa alcoba  
cobrizada Janes  
IMBC 0587  
Chapa baño  
cobrizada Janes

IMAP 0587  
Chapa alcoba  
pavonada antique Janes  
IMBP 0587  
Chapa baño  
pavonada antique Janes

IMAD 0587  
Chapa alcoba dorada  
Janes  
IMBD 0587  
Chapa baño dorada  
Janes

IMEP 0587  
Chapa janés bola entrada  
principal satin níquel

IMCS 0101  
Cerrojo satinado cepillado Janes

IMTP 6803  
Tope puerta  
piso pavonado

IMTP 6802  
Tope puerta  
piso cromado  
IMTP 6801  
Tope puerta  
piso satin  
níquel

IMTP 0884  
Tope puerta  
piso satin  
níquel

**NUEVO**



IMCS 0001  
Chapa Janes closet  
corrediza con manija



IMAP 0803  
Chapa palanca alcoba pavonada Janes  
IMBP 0803  
Chapa palanca baño pavonada Janes

IMAS 0804  
Chapa palanca alcoba satinada Janes  
IMBS 0804  
Chapa palanca baño satinada Janes  
IMAP 3411  
Chapa palanca alcoba satinada Eco  
IMAP 3412  
Chapa palanca baño satinada Eco

IMOM 0205  
Ojo mágico  
200° cromo  
35 x 60 mm  
IMOM 0204  
Ojo mágico  
200° dorado  
35 x 60 mm



IMOM 0202  
Ojo mágico  
200° dorado  
25 x 42 mm



IMOM 0203  
Ojo mágico  
200° cromo  
25 x 42 mm



IMTP 0002 Tope de puerta magnético



IMCE 9171  
Chapa bialiti entrada  
principal palanca satin níquel



IMTA 1000  
Tarugo de madera 8 x 30 mm  
por kilo 760  
IMTA 1002  
Tarugo de madera 10.1 x 40 mm  
por kilo 410  
IMTA 1003  
Tarugo de madera 12.1 x 40 mm  
por kilo 250  
IMTA 1004  
Tarugo de madera 6.1 x 35 mm  
por kilo 1152



OTPV 0027 Pivote para puerta



IMPL 5116  
Platina rectangular galvanizada  
51 x 16 x 1.6 mm

IMPL 7619  
Platina rectangular  
galvanizada  
76 x 19 x 1.8 mm

IMPL 6416  
Platina rectangular  
galvanizada  
64 x 16 x 1.6 mm



IMAP 3412  
Chapa Bialiti palanca baño satin níquel  
IMAP 3411  
Chapa Bialiti palanca alcoba satin níquel

IMSE 3054  
Soporte vidrio níquel  
cepillado Ø20 x H 40 mm

IMSE 3055  
Soporte vidrio  
níquel  
cepillado  
Ø20 x  
H 50 mm

IMSE 3056  
Soporte vidrio  
níquel  
cepillado  
Ø20 x  
H 60 mm

IMSE 3057  
Soporte vidrio  
níquel  
cepillado  
Ø20 x  
H 100 mm

IMSE 3058  
Soporte vidrio  
níquel  
cepillado  
Ø30 x  
H 100 mm

IMSE 3059  
Soporte vidrio  
níquel  
cepillado  
Ø30 x  
H 150 mm



IMSE 5401  
Soporte esquinero 78.5 x 78.5 x 60 mm  
para patas mesa galvanizando

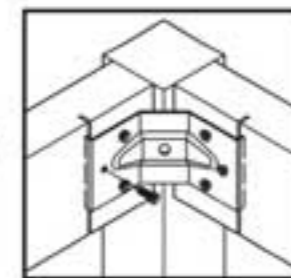

IMSE 3051  
Soporte vidrio níquel  
cepillado  
Ø12 x 19 mm

## SISTEMA PLEGABLE "FOLDING" DE ACCESO TOTAL Liviano



JRHP 1601 Sistema plegable brazo escualizable acceso total (kit. 2 puertas)

## REPUESTOS VARIOS JOHNSON



JRSA 0180 Riel aluminio sistema corredizo interno una puerta (bolsillo) 1,80 mts.



JRSA 0240 Riel aluminio sistema corredizo interno una puerta (bolsillo) 2,40 mts.



JBAR 1125 Bolsa accesorios riel corredizo una puerta (bolsillo) riel aluminio



JRRB 1025 Carro rodachinas sistema corredizo pesado y bolsillo interno



IMGR 2850 Guía y rueda para riel corredizo

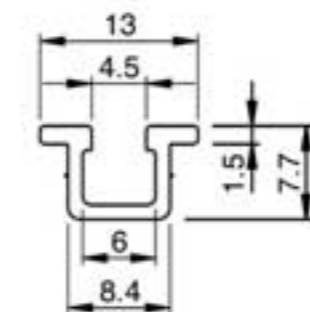
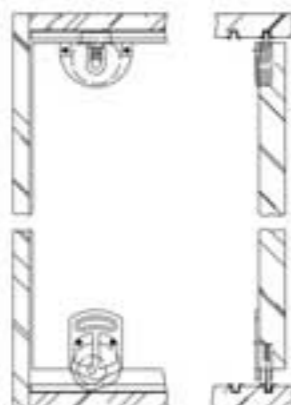

IMRP 0001 Riel económico corredizo en U plástico L. 180 mm

## SISTEMA JOHNSON PLEGABLE LIVIANO 16 KILOS POR PUERTA - MEDIDAS: 1.50 / 1.80 Y 2.40 METROS



JRCP 0150 Riel acero closet plegable 1.50 mt  
JRCP 0180 Riel acero closet plegable 1.80 mt  
JRCP 0240 Riel acero closet plegable 2.40 mt



JBAR 0006 Bolsa accesorios sistema plegable liviano 2 puertas  
JBAR 0051 Bolsa accesorios sistema plegable liviano 4 puertas

## SISTEMA JOHNSON PLEGABLE PESADO 25 KILOS POR PUERTA - MEDIDAS: 1.80 Y 2.40 METROS



JRSA 0180 Riel aluminio closet plegable sistema pesado 1.80 mt  
JRSA 0240 Riel aluminio closet plegable sistema pesado 2.40 mt



JBAR 1103 Bolsa accesorios sistema plegable pesado 2 puertas

## SISTEMA JOHNSON CORREDIZO LIVIANO 25 KILOS POR PUERTA



JRPC 0150 Riel acero closet corredizo liviano 1.50 mt  
JRPC 0180 Riel acero closet corredizo liviano 1.80 mt  
JRPC 0240 Riel acero closet corredizo liviano 2.40 mt



JBAR 2202 Bolsa accesorios sistema corredizo liviano 2 puertas (1 freno)  
JBAR 2203 Bolsa accesorios sistema corredizo liviano 3 puertas (2 freno)

NOTA: SE VENDEN LOS REPUESTOS DE LOS DIFERENTES SISTEMAS.

REPUESTOS JOHNSON SISTEMA CORREDIZO LIVIANO



JRGP 2135  
Guía para puertas corredizas  
3/4" o 1-3/8" de 19mm a 35mm



JRGP 2134  
Guía para puertas corredizas  
1 - 1/8" o 1-3/4" de 29mm a 44mm



JRSR 2155  
Tope freno puerta  
sistema corredizo



JRTA 2165  
Tope amortiguador para riel  
corredizo acero liviano  
3 ó 4 puertas



JRAR 1020  
Rodachina para riel  
plegable pesado



JRFP 1155  
Freno superior para riel  
corredizo acero pesado



IMPG 4120  
Plato metálico giratorio 360°  
16.7 x 16.7 cm - resistencia 100 kilos



IMBT 0035  
Bandeja portateclado  
PVC gris con riel 35 cm



IMBT 0135  
Bandeja portateclado  
PVC negro con riel 35 cm

**NUEVO**

IMLB 0109  
Bandeja portateclado  
negro ECO 35 cm

IMBT 0108  
Bandeja portateclado  
Gris ECO 35 cm

REPUESTOS VARIOS JOHNSON



JRRB 1703  
Bisagra sistema puerta  
plegable pesado (unidad)



JRAR 2216  
Accesorio recto  
(colgadero)



JRSP 1711  
Soporte inferior sistema  
puerta plegable pesado



JRPP 0118  
Base riel plegable.



JRAC 2238  
Accesorio curvo  
(colgadero)



Riel cajón metálico - rodachina  
Blanco Negro Café  
IMRB 0030 IMRN 0030 IMRF 0030  
IMRB 0035 IMRN 0035 IMRF 0035  
IMRB 0040 IMRN 0040 IMRF 0040  
IMRB 0045 IMRN 0045 IMRF 0045  
IMRB 0050 IMRN 0050 IMRF 0050  
IMRB 0055 IMRN 0055 IMRF 0055

REPUESTOS JOHNSON SISTEMA PLEGABLE LIVIANO



JRPS 1801  
Pivote superior sistema  
puerta plegable liviano



JRPI 1807  
Pivote inferior graduable  
sistema puerta plegable  
liviano

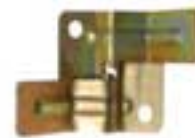

JRAP 1808  
Alineador para puertas  
plegables livianos



JRRP 1810  
Recibidor de pivote superior  
sistema plegable liviano  
en el riel



JRAP 1811  
Base para pivote inferior  
sistema plegable liviano



Riel puerta interna negro  
IMRIN 040 40 cm  
IMRIN 045 45 cm  
IMRIN 050 50 cm



IMLB 3002  
Brazo radiola cromado  
192mm

**NUEVO**



Riel over the top  
IMRO 7772 35 cm  
IMRO 7773 40 cm



Riel Full extensión galvanizado auto cierre 45 mm  
IMREA 040 IMREG 025 IMREG 030 IMREG 035 IMREG 040 IMREG 045 IMREG 050 IMREG 055  
Riel Full extensión galvanizado 36 mm  
IMREG 130 IMREG 135 IMREG 140 IMREG 145 IMREG 150  
Riel Full extensión galvanizado 45 mm  
IMREN 030 IMREN 035 IMREN 040 IMREN 045 IMREN 050 IMREN 055  
Riel Full extensión negro 45 mm  
IMRPG 030 IMRPN 030  
Riel portateclado - balineras 12" galvanizado  
IMRPG 035 IMRPN 035  
Riel portateclado - balineras 14" galvanizado

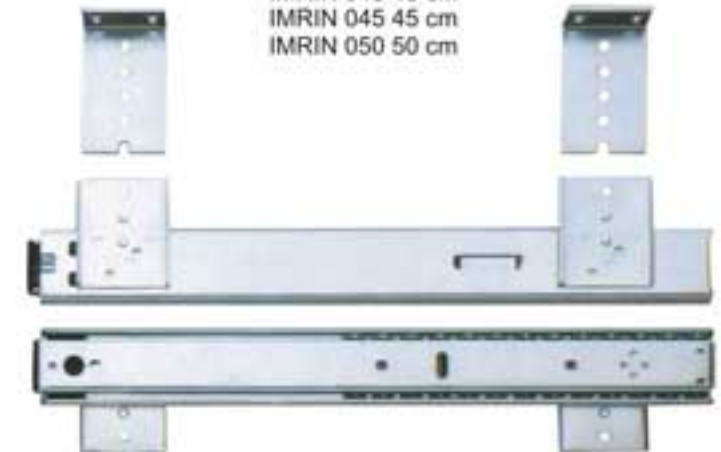

IMRPG 030  
Riel portateclado - balineras  
12" galvanizado  
IMRPG 035  
Riel portateclado - balineras  
14" galvanizado

IMRPN 030  
Riel portateclado - balineras  
12" negro  
IMRPN 035  
Riel portateclado - balineras  
14" negro



IMPA 1214  
Pie amigo fijo 12 x 14 blanco - und.  
IMPA 1012  
Pie amigo fijo 10 x 12 blanco y café - und.  
IMPA 1008  
Pie amigo fijo 10 x 8 blanco y café - und.  
IMPA 0608  
Pie amigo fijo 6 x 8 blanco y café - und.  
IMPA 0405  
Pie amigo fijo 4 x 5 blanco - und.



IMPA 5770  
Pie amigo palanca  
escualizable  
blanco - par 12"



IMPA 5950  
Pie amigo metal  
escualizable 8"  
blanco - par  
IMPA 5952  
Pie amigo metal  
escualizable 12"  
blanco - par



IMLS0057  
Soporte entrepaño  
plano con buje cromado



CGSB 5305 blanco  
CGSY 5305 yute  
CGSF 5305 café  
Soporte para  
tubo de closet 1pulg.



IMBS 0023  
Buje niquelado  
soporte entrepaño



IMSN 0021  
Soporte entrepaño  
niquelado  
IMSD 0022  
Soporte entrepaño  
dorado



IMSE 8250  
Soporte entrepaño  
plástico transparente  
Ø. 5 mm pin



IMSE 8521  
Soporte plástico  
espejo transparente



IMSV 8494  
Soporte vidrio  
cromado chupa



IMLS0032  
Soporte chupa  
vidrio Eco



IMVR 5441  
Vaiven bola escualizable  
43 mm bronce  
IMVR 5442  
Vaiven bola escualizable  
43 mm satín níquel



IMVR 0882  
Vaiven bola escualizable  
50 mm bronce  
IMVR 0881  
Vaiven bola escualizable  
50 mm satín níquel



IMVR 0883  
Vaiven bola escualizable  
60 mm bronce  
IMVR 0884  
Vaiven bola escualizable  
60 mm satín níquel



IMSV 8388  
Soporte vidrio media  
luna satín níquel



IMLS0008  
Soporte Vidrio  
lateral cromado



CGSY 5015 color yute  
CGSF 5015 color café  
CGSB 5015 color blanco  
Soporte rectangular 19mm



CGSY 5010 color yute  
CGSF 5010 color café  
CGSB 5010 color blanco  
Soporte rectangular 15mm



CGSY 5005 color yute  
CGSF 5005 color café  
CGSB 5005 color blanco  
Soporte redondo



IMSV 8406  
Soporte entrepaño  
vidrio. níquel



IMLD0518  
Deslizador  
plástico  
blanco 18mm



IMLD0515  
Deslizador  
plástico  
blanco 15mm



IMBS 0040  
Bumpon  
6,4 x 1,6 mm  
x 136 unidades



IMHG 2360  
Herraje gabinete  
superior  
juego blanco - par



IMSE 8905  
Soporte pared vidrio  
lujo níquel cepillado (S)



IMSE 8906  
Soporte pared vidrio  
lujo níquel cepillado (M)



IMSE 8907  
Soporte pared vidrio  
lujo níquel cepillado (L)



IMSC 0295  
Soporte lujo  
cuadrado vidrio níquel  
cepillado 57 x 44 x 24 mm  
(3-18 calibre vidrio)



IMAS0024  
Gancho perchero  
sencillo satín níquel



IMAS0008  
Gancho perchero doble  
satín níquel n08



IMTL 1870  
Manija puerta vidrio  
níquel cepillada



IMSS1006  
Soporte vidrio media luna plano satín níquel peq. s  
IMSS1007  
Soporte vidrio media luna plano satín níquel med. m  
IMSS1008  
Soporte vidrio media luna plano satín níquel gran. l



IMBP 9628  
Bisagra para puerta de vidrio  
metálica negra - par



IMCP 0931  
Complemento puerta  
vidrio en U con adhesivo



IMBI 9625  
Bisagra pivote en L  
con bujes y tornillos



IMTP 0932  
Tiradera puerta vidrio en U  
con adhesivo



IMLS0150  
Soporte invisible para repisas de 150mm  
IMLS0200  
Soporte invisible para repisas de 200mm  
IMLS0250  
Soporte invisible para repisas de 250mm  
IMLS0300  
Soporte invisible para repisas de 300mm  
IMLS0350  
Soporte invisible para repisas de 350mm



IMAS0010  
Gancho perchero doble  
satín níquel n10  
IMAS0012  
Gancho perchero doble  
antocado n10  
IMAS0110  
Gancho perchero doble  
cromado n10



IMBN 7501  
Bisagra golpe niquelada par ct.



IMBO 0192  
Bisagra mariposa bronce  
1-11/16 x 3-1/16



IMBN 0011  
Bisagra doble acción negra



IMMG 7870  
Braso metalico 8 Kg Gas lift Mechanic  
IMBG0039  
Braso gas cabeza metalica 80  
newton con tornillo.

IMMG 0002  
Braso metalico 8 Kg Gas lift Mechanic

Tabla de Instalación Unidades: mm

Angulo de apertura	A	B	C
80°	238	65+1	37
90°	222	60+1	37
100°	213	52+1	37



IMBE 0276  
Brazo escualizable Ferrari 75° a 105° - resistencia x puerta 4 kg

IMBC 1920  
Bisagra golpe pavonada roja par ct.



IMBC 1921  
Bisagra golpe dorada par ct.



IMBP 7500  
Bisagra golpe pavonada  
amanilla par ct.



IMBM 0590  
Bisagra maquina de coser pavonada  
antique Pav. 1-1/4x3-1/8



IMCI 0508  
Cerradura doble pico de  
loro cromo de 19 x 22 mm



IMCV 8640  
Cerradura para puerta  
vidrio plástica negra



IMCV 4081  
Cerradura puerta  
vidrio cromo sencilla



IMCV 4175  
Cerradura puerta vidrio  
doble cromada



IMCH3891  
Chapeta para baul satin niquel



OTAN 1612  
Tornillo y chazo  
2 x 5.16 pulg.



OTAN 1410  
Tornillo y chazo  
1 1/4 x 1 1/8 pulg.

Ejemplo de Instalación

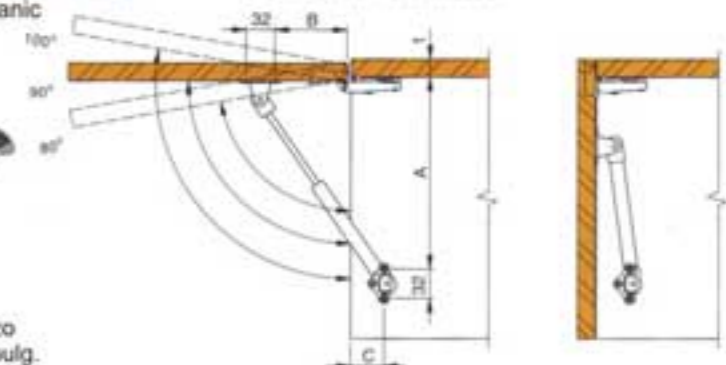

IMVR 1000  
Vaiven resorte  
niquelado



IMVR 2000  
Vaiven resorte  
pavonado



IMVR 3000  
Vaiven rodillo caja  
pavonado



IMVR3006  
Vaivén rodillo caja  
pavonado rojo



IMVR3005  
Vaivén rodillo  
caja zincado



IMVM 4011  
Vaiven mag. push  
button sencillo



IMVM 0908  
Vaiven mag. push  
button doble



IMBB 0571  
Bisagra bronce embutir  
Ø. 10 mm  
H. 11 mm L. 16.5 mm  
E. 2.5 mm F. 2 mm



IMLC6701  
Chapa trampa archivador  
negra (sola)



IMVN 2110  
Vaiven tope magnético  
negro



IMVF 2110  
Vaiven tope magnético  
café



IMVB 2110  
Vaiven tope magnético  
blanco



IMLC6417  
Chapa vitrina cromada



IMCJ 3658  
Chapa cobre dorada ct.



IMBB 0572  
Bisagra bronce embutir  
Ø. 12 mm  
H. 13.5 mm L. 20 mm  
E. 3.5 mm F. 2.2 mm



IMLC6700  
Sistema trampa  
archivador  
completo negro  
600mm



IMHA6105  
Cerradura mueble puerta  
corrediza push cromo  
de 19 x 22mm



IMLC3102  
Chapa escritorio cierre  
automatico resorte 22mm  
Eco cromo



IMLC0138  
Chapa mueble cilindro 22mm  
pesada Eco cromada



IMLC0101  
Chapa mueble cilindro 22mm  
liviana Eco cromada



IMLC3100  
Chapa mueble cilindro largo  
32mm Eco cromada

NUEVO

NUEVO

NUEVO

NUEVO

NUEVO

NUEVO

NUEVO

NUEVO

